



Info generali

Decorativo - Sospensione

Indoor suspended lamp with multiple integrated LED sources and direct light emission

Ean	8021696247274
Articolo	GEMINI SP D81 BIANCO
Installazione	Suspension
Garanzia	5 years
Peso lordo	4.75 kg
Volume	0.07744 m ³

Info tecniche e installative

Peso netto	2.06 kg
Classe di isolamento	I
Grado di protezione	IP20
Conformità	CE
Temperatura d'esercizio	0° ~ +40 °C
Dimmer	No dimmerable, On-Off
Alimentazione	220-240 V AC 50/60 Hz
Alimentatore	In-built, included YES (by qualified operators only), electronic

D

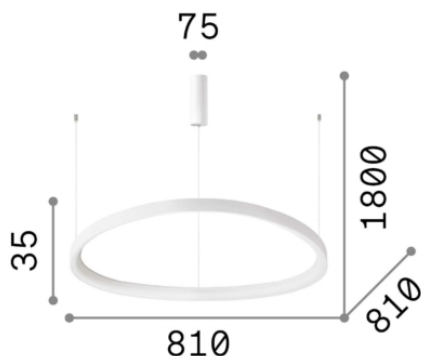

Info sorgente e prestazionali

Sorgente integrata	Integrated LED module
Sorgente sostituibile	YES (by qualified operators only)
Potenza	LED 60W
Emissione	Direct
Consumo massimo	max 60 W
Caratteristiche LED	LED SMD
CCT	3000 K
Durata LED (t. 25°C)	50000 h
CRI	> 80
Flusso sorgente	8100 lm
Flusso utile	5280 lm
Potenza in stand-by	< 0.50